

for2-23.eps

$$\alpha = \frac{\kappa}{\sqrt{E}}$$

for3-01.eps

$$E = \frac{\sigma}{\varepsilon}$$

for3-02.eps

$$\rho_v = R_v \times \frac{A}{t}$$

for3-03.eps



for3-04.eps

Pagina-h2.eps

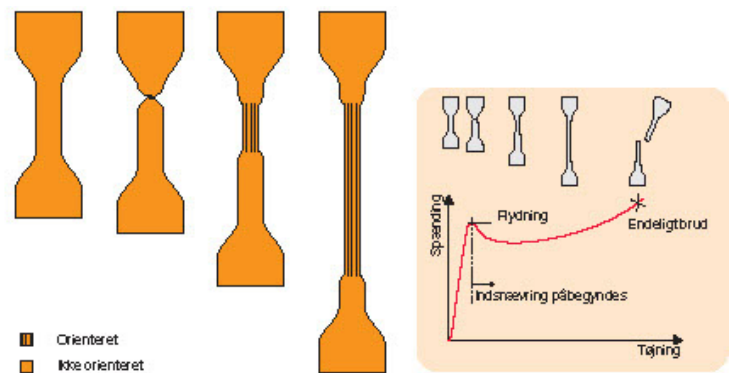

Pagina-v1.eps

pl-3-00.eps

Spezifikt  
volumen,  $V$

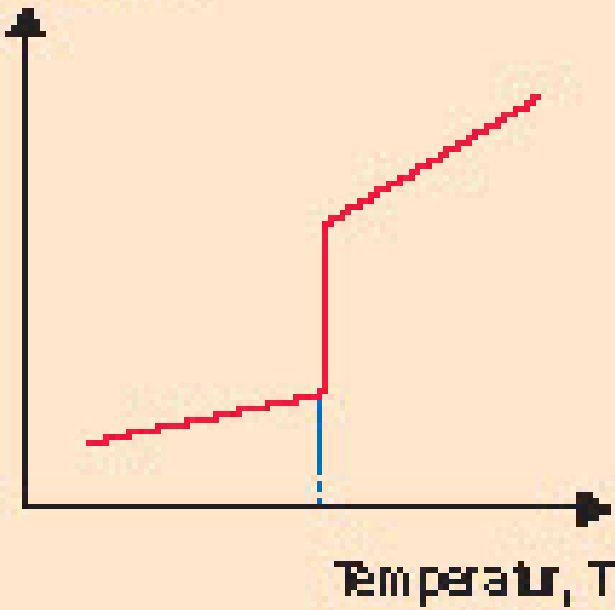

pl-3-01.eps

Spezifikt  
volumen

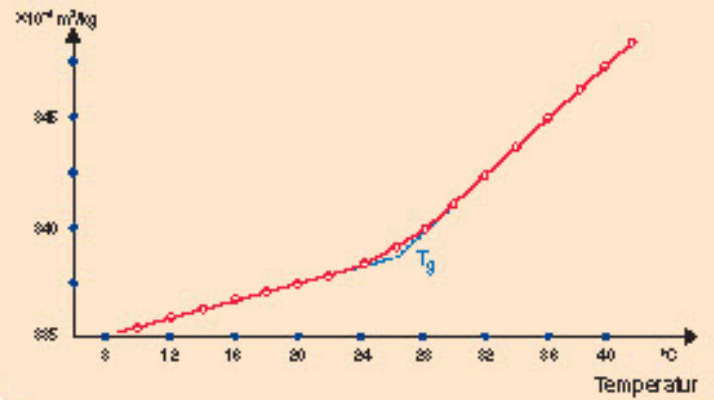

pl-3-02.eps

Spezifikt  
volumen

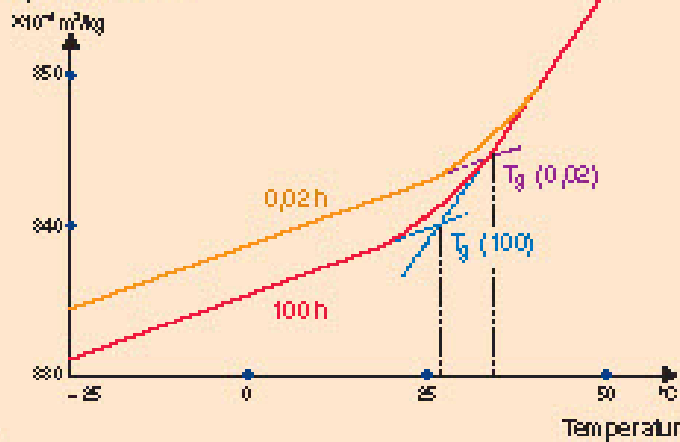

pl-3-03.eps

Spezifikt  
volumen

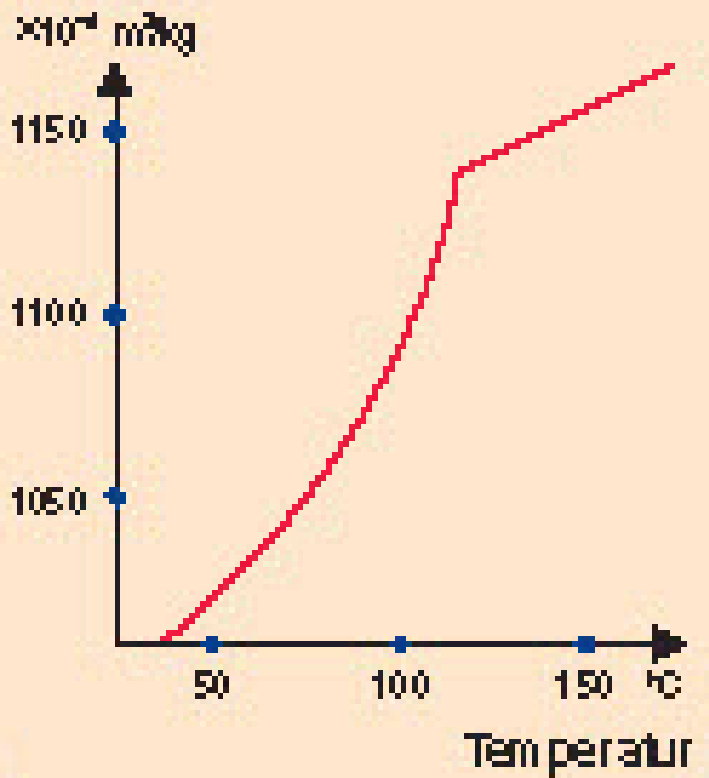

pl-3-04.eps

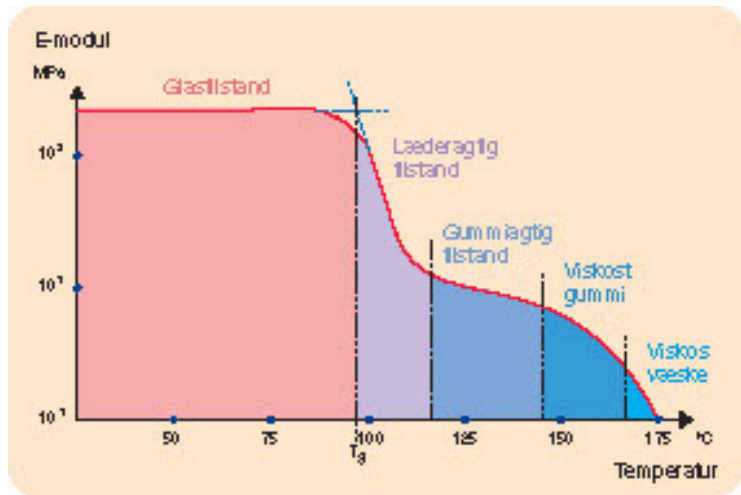

pl-3-05.eps

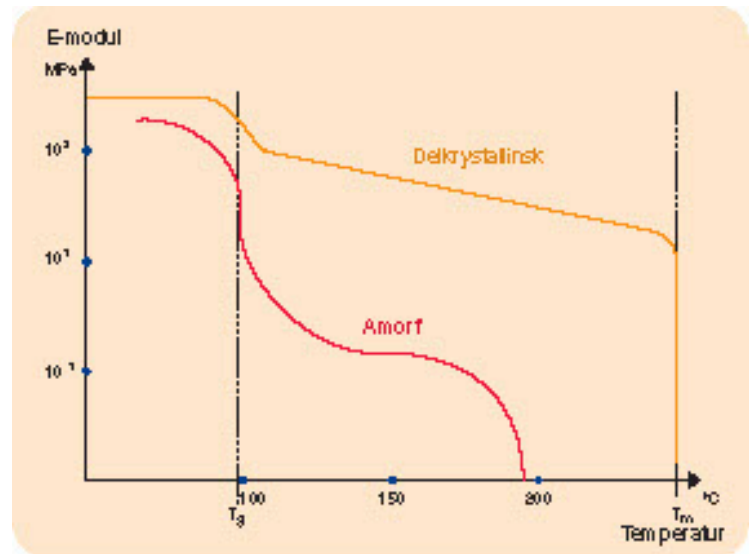

pl-3-06.eps

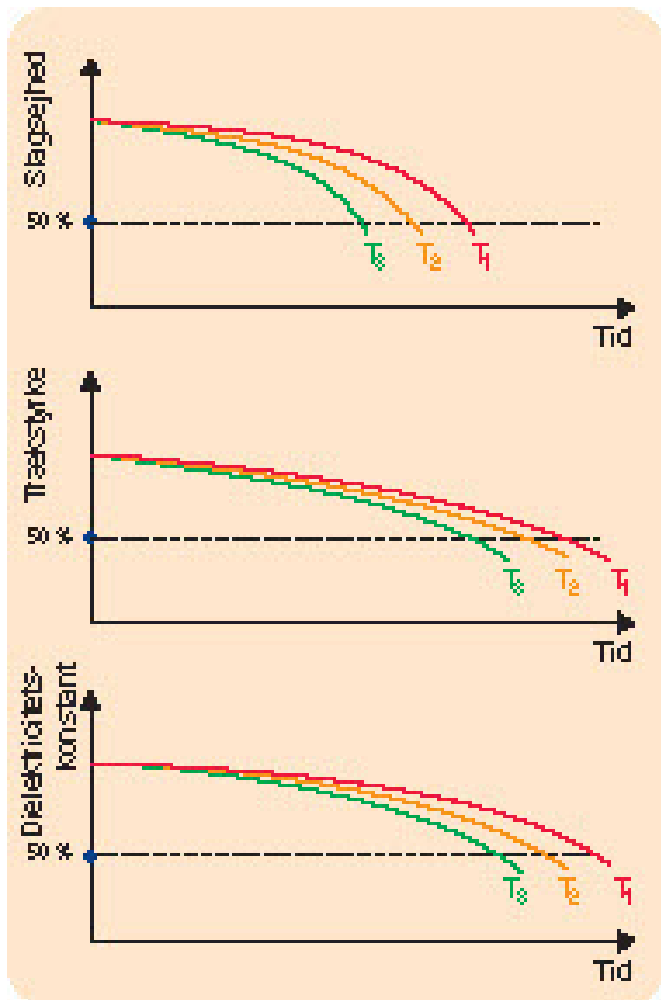

pl-3-07.eps

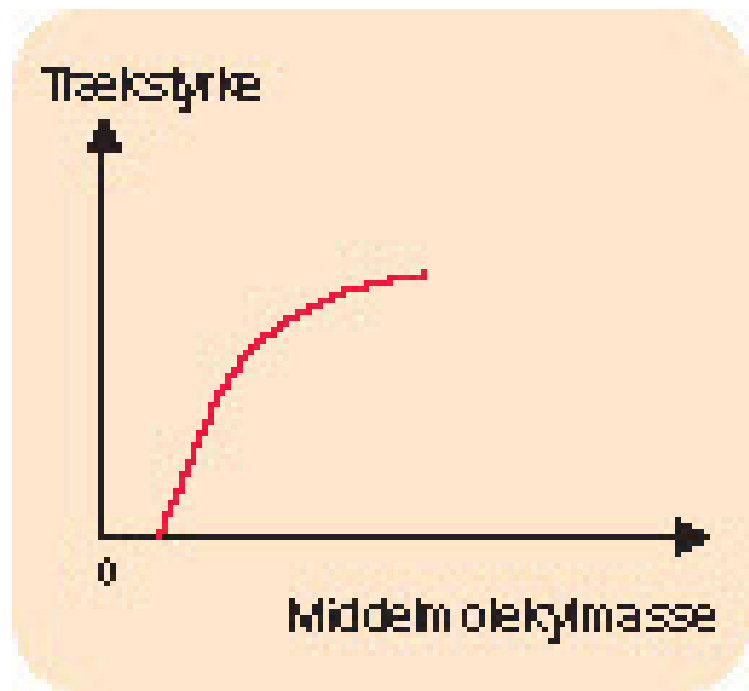

pl-3-08.eps

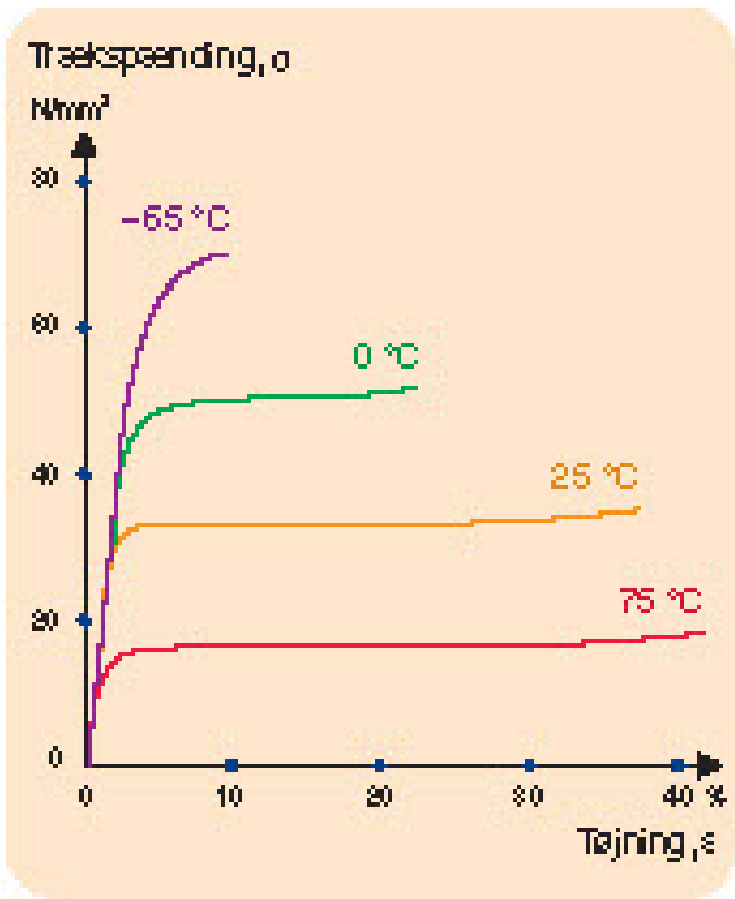

pl-3-09.eps

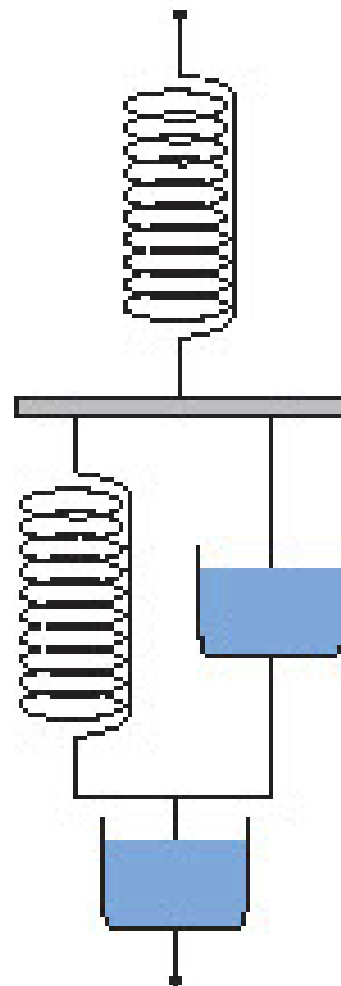

pl-3-10.eps

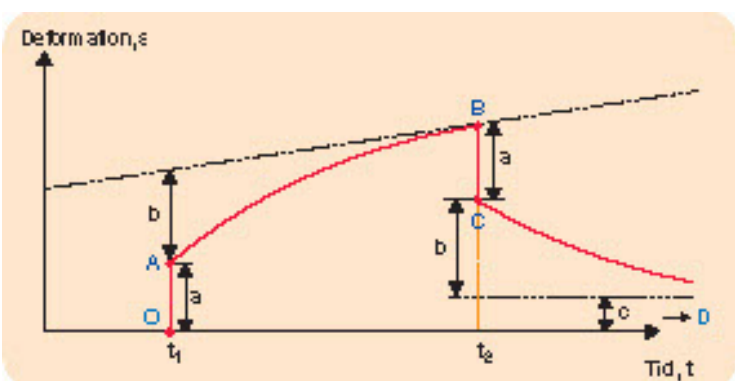

pl-3-11.eps

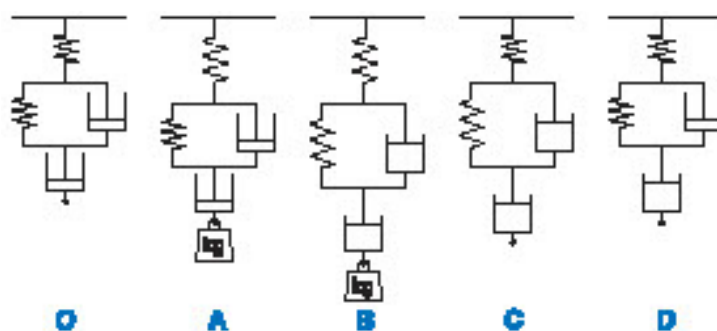

pl-3-12.eps

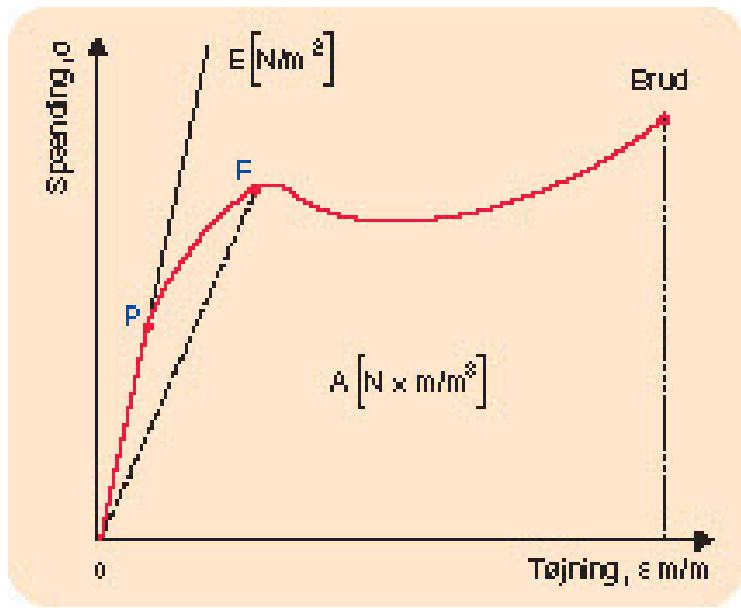

pl-3-13.eps

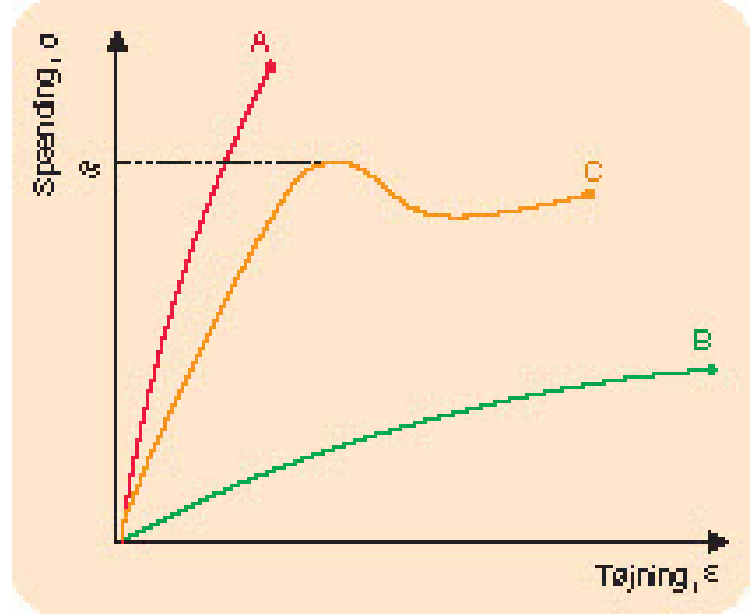

pl-3-14.eps

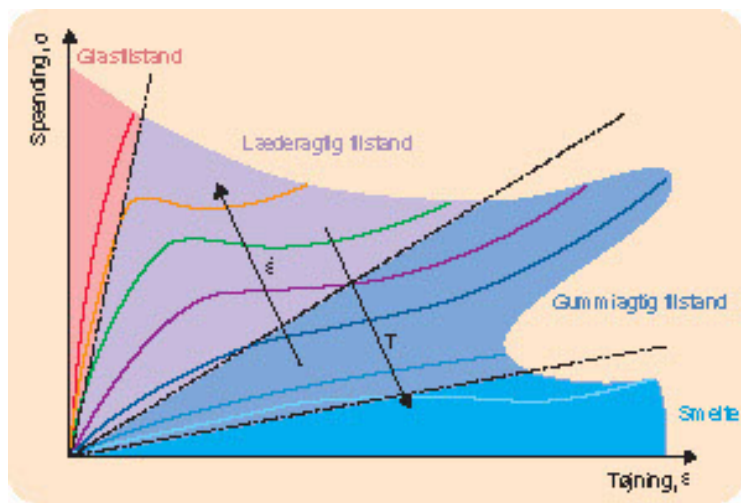

pl-3-15.eps

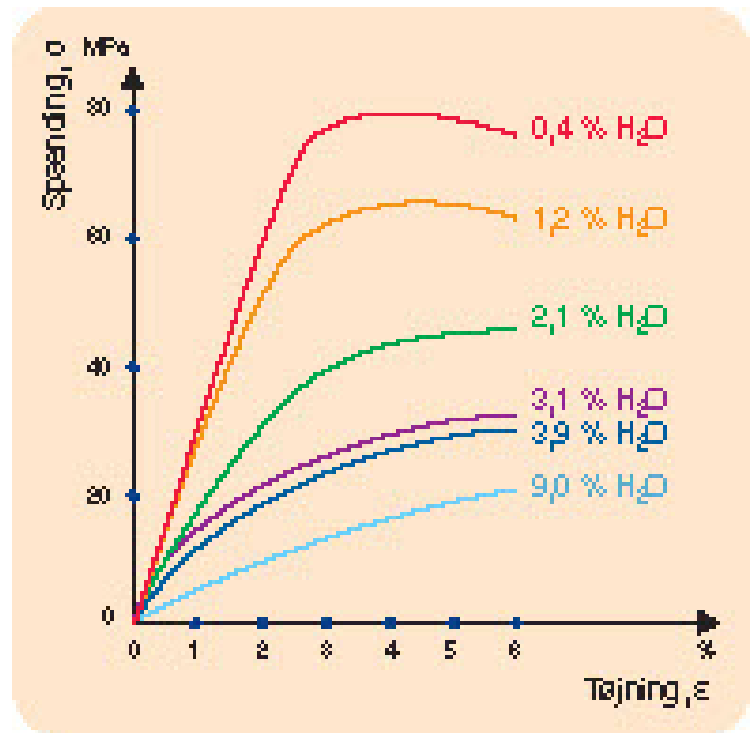

pl-3-16.eps

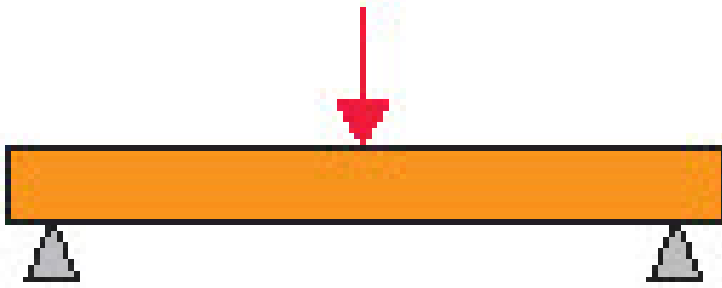

pl-3-17.eps

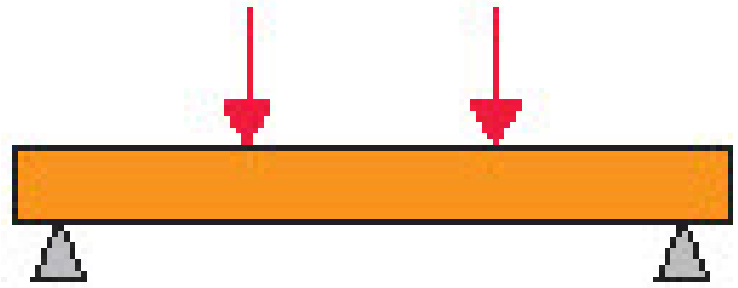

pl-3-18.eps

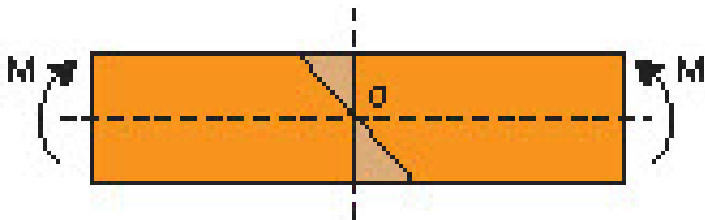

pl-3-19.eps

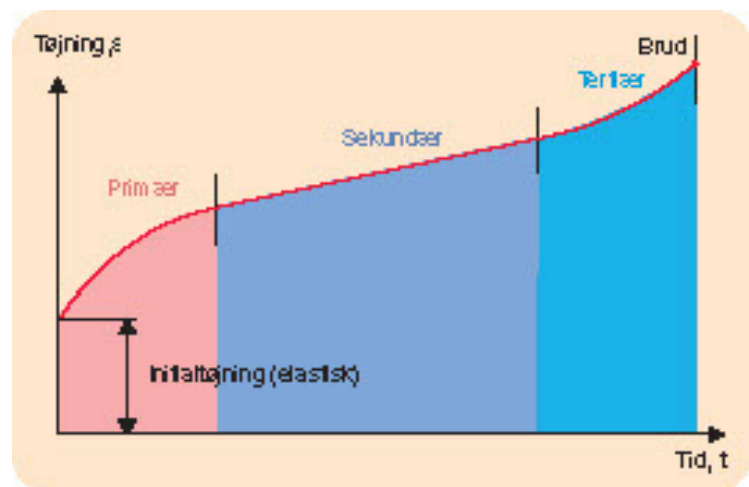

pl-3-20.eps

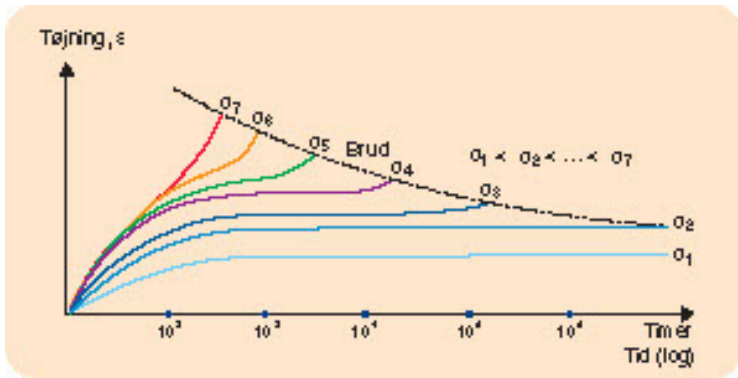

pl-3-21.eps

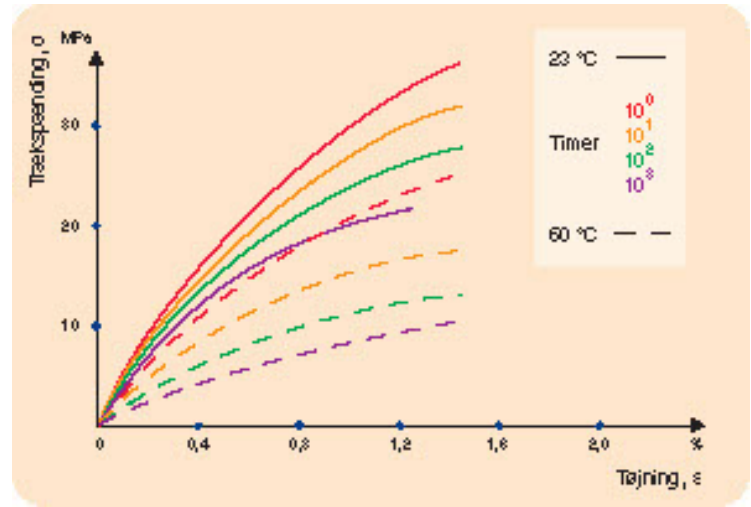

pl-3-22.eps

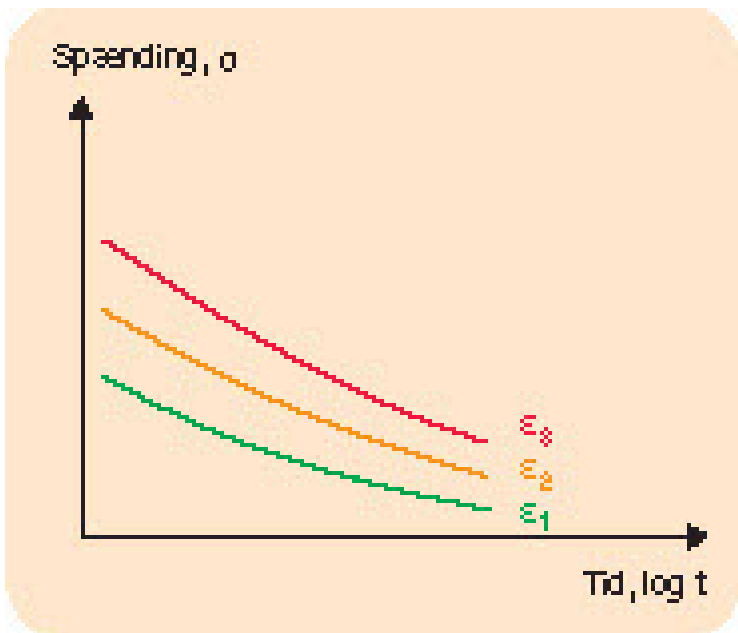

pl-3-23.eps

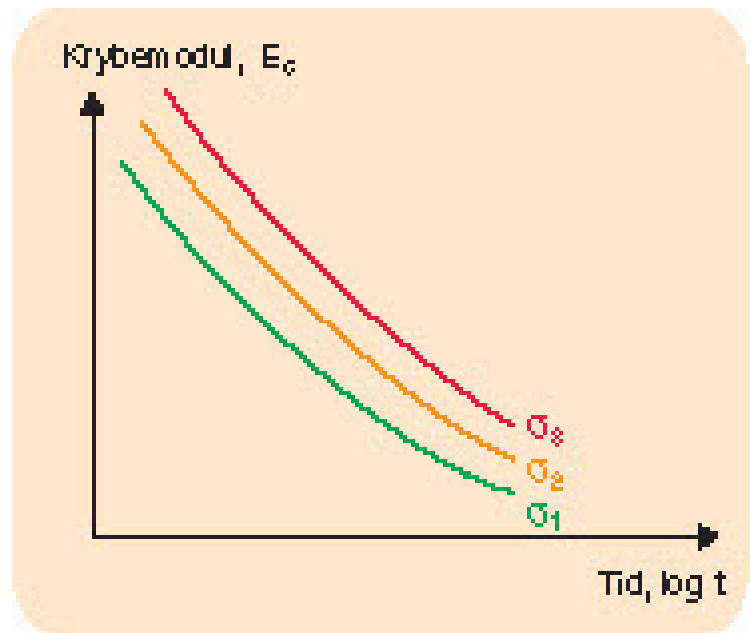

pl-3-24.eps



Spænding,  $\sigma$

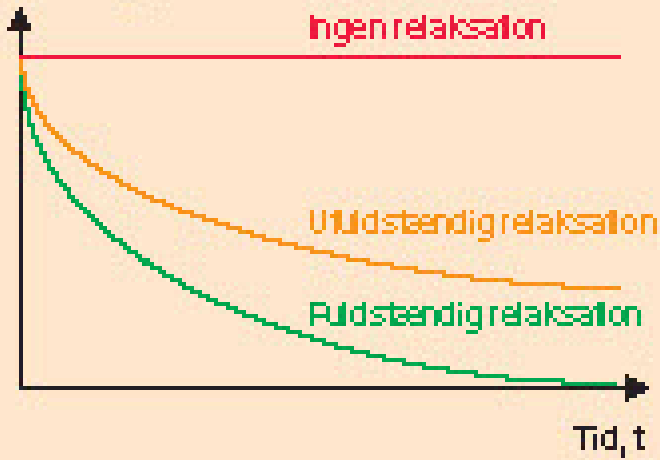

Shore A

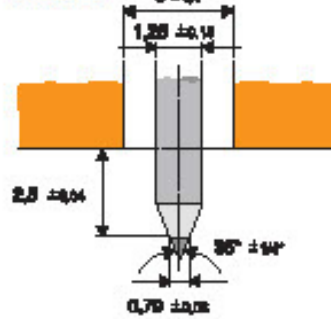

Shore D

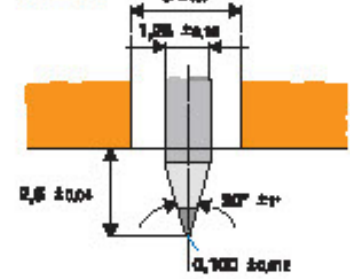

pl-3-25.eps

Shore A

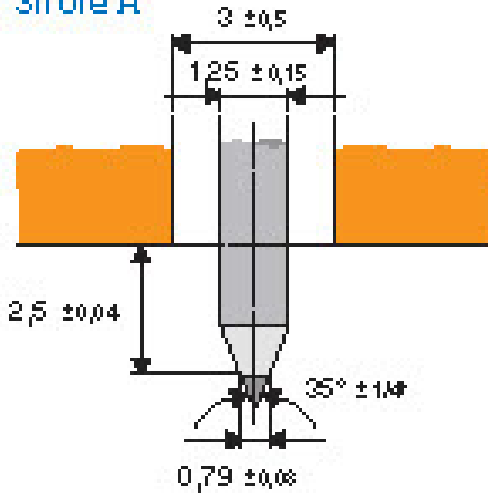

Shore D

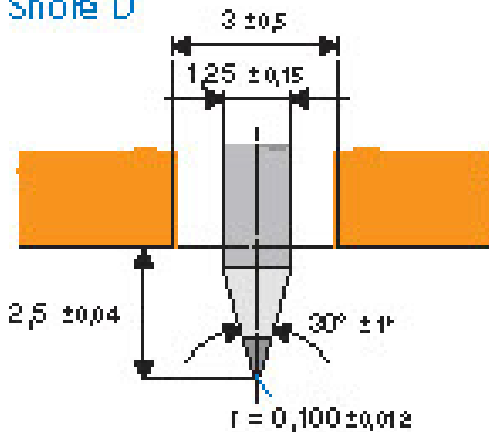

pl-3-26a.eps

pl-3-26.eps

E-modul, E

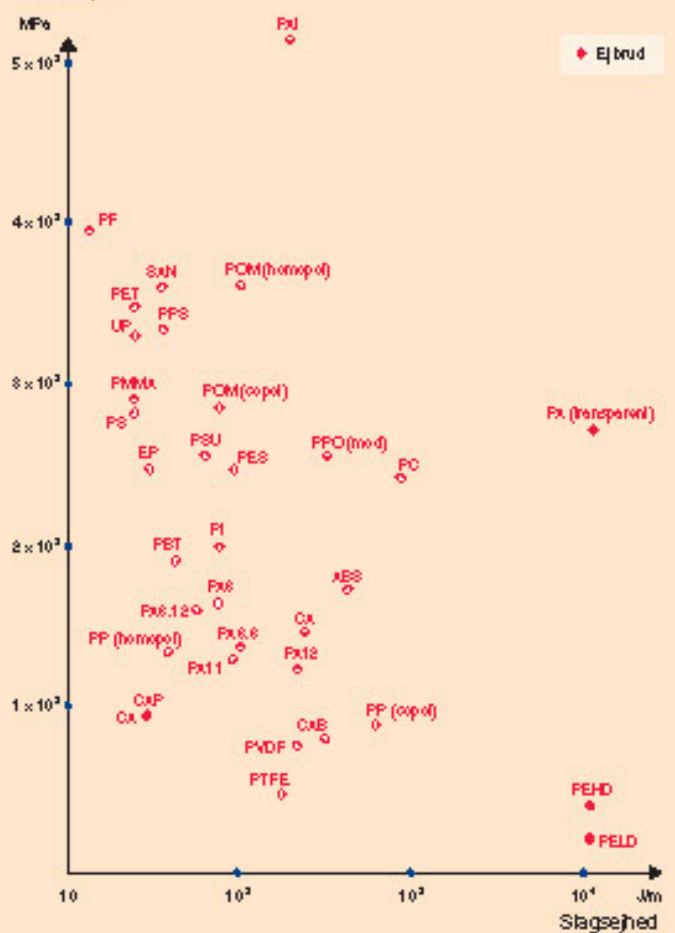

pl-3-27.eps

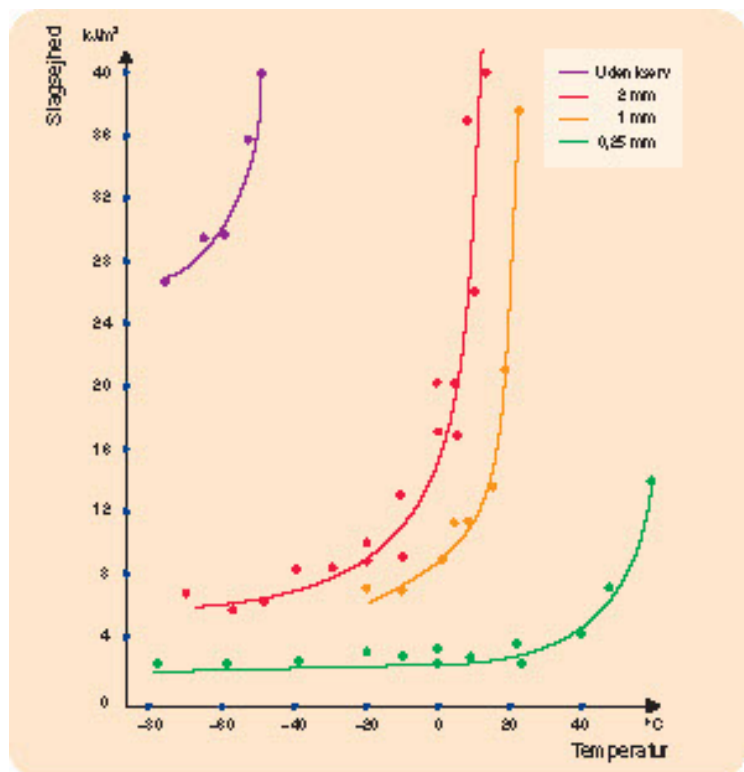
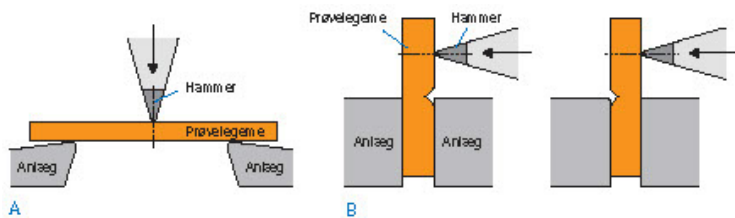

pl-3-28.eps

pl-3-29.eps

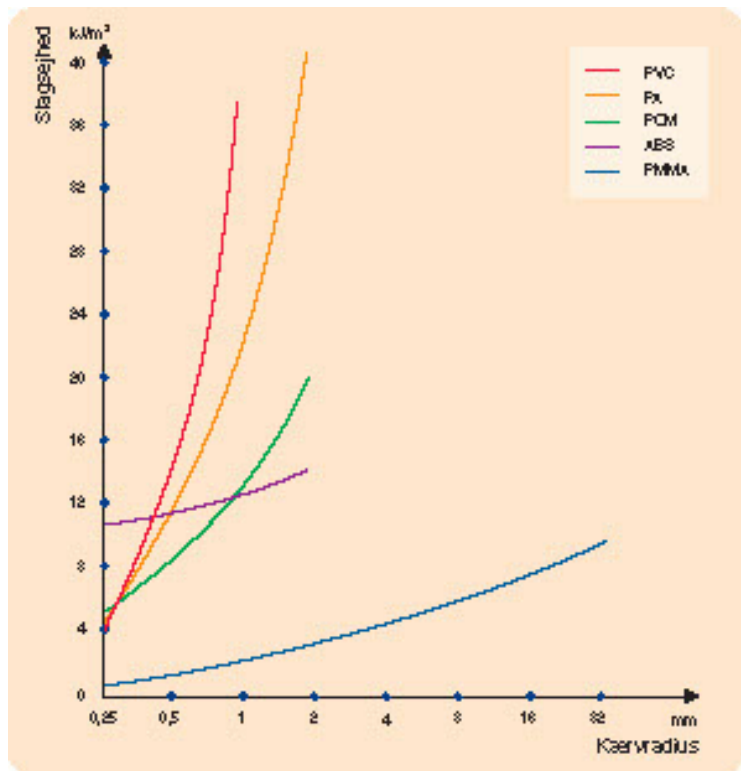

pl-3-30.eps

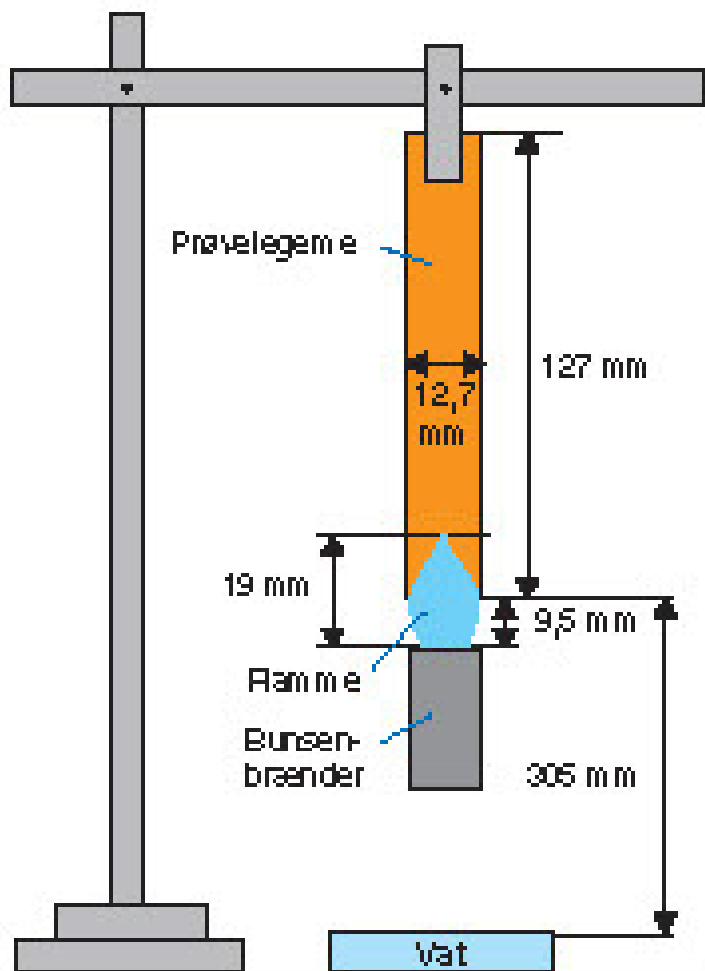

pl-3-31.eps

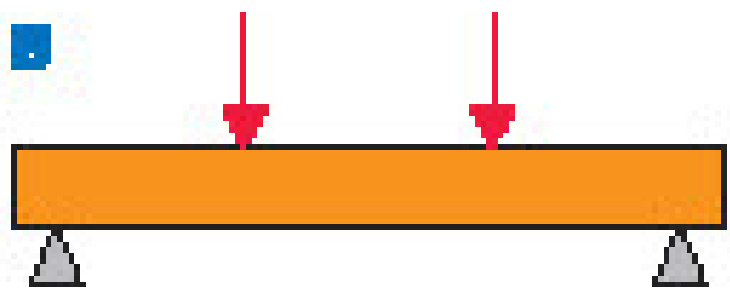
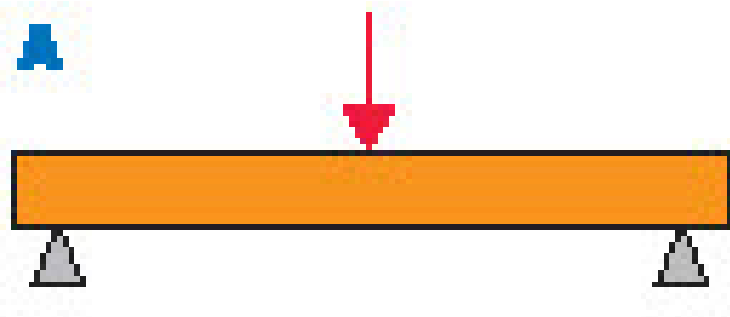

pl-3-178.eps